

TOSHIBA

Electron Tube, Device & Equipment

TECHNICAL DATA

MAGNETRON

E 3 5 7 1

Toshiba magnetron E3571 is a fixed frequency pulsed type magnetron intended for use in radar systems of various kinds of ships, such as sail boats, and fishing boats.

The peak output power is about 4 kW in the frequency range from 9380 to 9440 MHz.

The tube is an integral magnet type and is cooled by natural cooling.

The output fitting is designed to mate with a waveguide WR-90 (EIA).

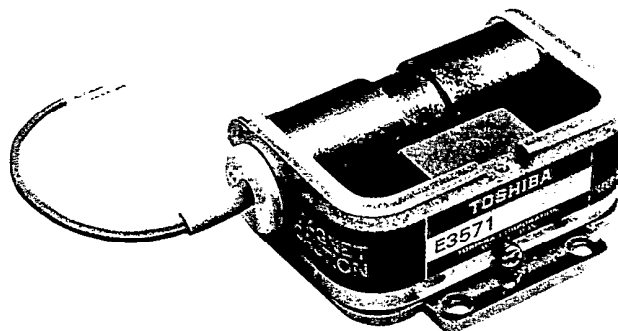

FEATURES

1. Low anode voltage
2. Compact size and light weight ,total weight is only 300 g
3. Negligible spurious level
4. Long life

GENERAL DATA

ELECTRICAL :

Frequency	9410 \pm 30 MHz
Heater voltage	6.3 V
Heater current	0.55 A
Cathode warm-up time	90 s

☆The information contained herein is presented only as a guide for the application of our products. No responsibility is assumed by TOSHIBA for any infringements of patents or other rights of the third parties which may result from its use. No license is granted by implication or otherwise under any patent or patent rights of TOSHIBA or others.

☆The information contained herein may be changed without prior notice.

It is therefore, advisable to contact to TOSIBA before proceeding with the design of equipment incorporating this product.

97. 7. 24



MECHANICAL :

Dimensional outline	See Dimensional outline
Power supply connection	See Power supply connection
Mounting position	Any
Magnetic field	Integral
Cooling	Natural
Weight (approx.)	300 g
Type of cathode	Indirectly heated oxide cathode

ABSOLUTE MAXIMUM RATINGS Note (1)(2)

	Minimum	Maximum	Unit
Heater voltage	5.7	6.9	V
Heater surge current	—	3	A
Cathode warm-up time	90	—	s
Peak anode voltage	3.5	3.9	kV
Peak anode current	2.5	3.5	A
Average anode current	—	3.5	mAav
Rate or rise of anode voltage Note (3) ...	—	55	kV/ μ s
Pulse width	0.05	1.1	μ s
Duty	—	0.001	—
Peak anode input power	—	13	kW
Average anode input power	—	13	W
load VSWR	—	1.5	—
Anode temperature (operating)	—	120	$^{\circ}$ C
Storage temperature	-40	+60	$^{\circ}$ C
Storage humidity Note (4)	—	95	%

Note :

- (1)None of the absolute maximum ratings should be exceeded under any circumstance even for an instant or transient, since to do so may cause damage to the tube. A combination of the maximum rating conditions can not be guaranteed.
- (2)All the voltage parameters are in reference to the cathode voltage.
- (3)The rate of rise of anode voltage is defined as the steepest tangent to the anode voltage pulse above 80% amplitude. Any capacitance in the viewing system must not exceed 6pF.
- (4)The condition is not dewing or blowing the water.

TYPICAL OPERATION Note (1)

		Unit
Heater voltage	6.3	V
Peak anode voltage	3.7	kV
Peak anode current	3.0	A
Average anode current	1.5	mAav
Rate of rise of anode voltage, Note (2)	50	kV/ μ s
Pulse width	1.0	μ s
Duty	0.0005	—
Peak output power	4.0	kW
Average output power	2.0	W
RF band width	2.4	MHz

Note :

- (1) All the voltage parameters are in reference to the cathode voltage.
 (2) The rate of rise of anode voltage is defined as the steepest tangent to the anode voltage pulse above 80% amplitude. Any capacitance in the viewing system must not exceed 6pF.

OPERATING CHARACTERISTICS

Operating conditions

Pulse width : $1 \mu s$
Duty : 0.0005
Load VSWR : 1.1 Max.

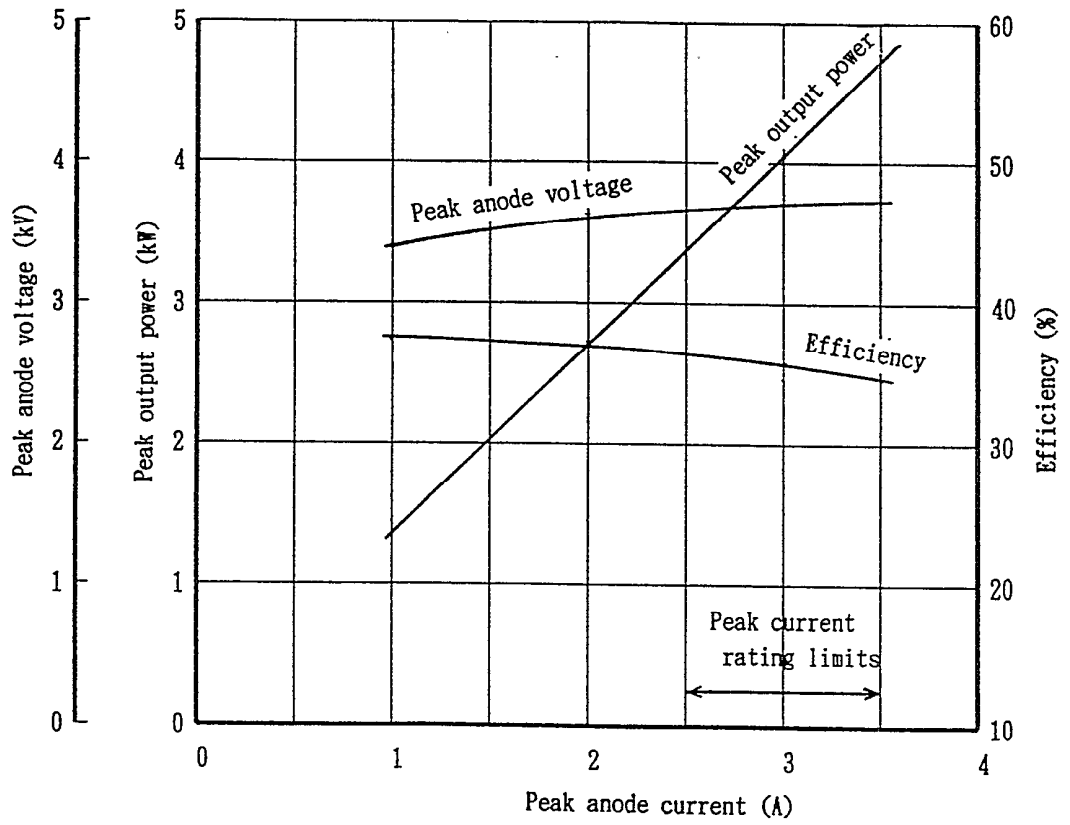

DIMENSIONAL OUTLINE

Unit : mm

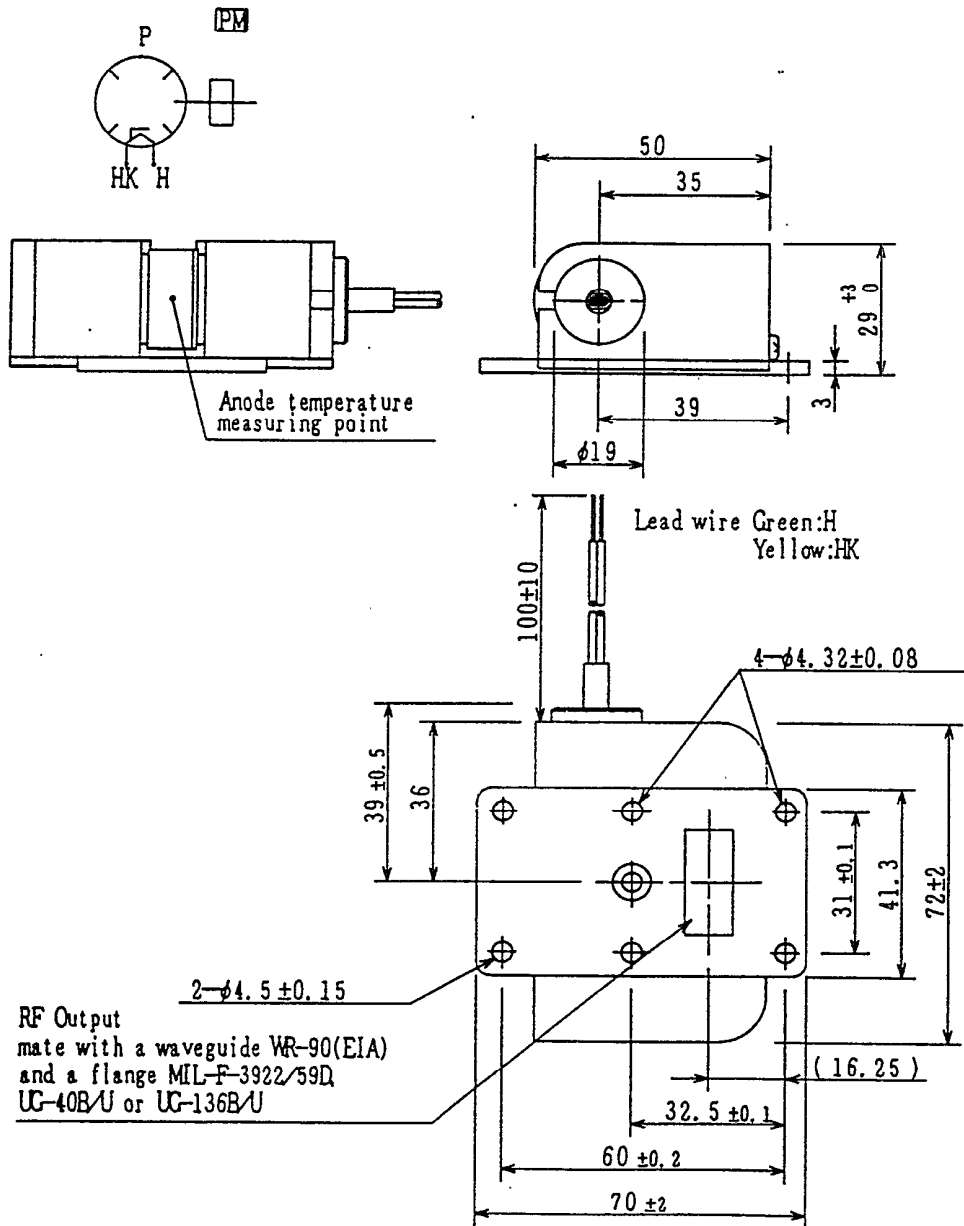

Note:

As the insulation cover of the lead wire does not withstand standard cathode high voltage, the lead wires must be located with safe distance from the earth potential portions.

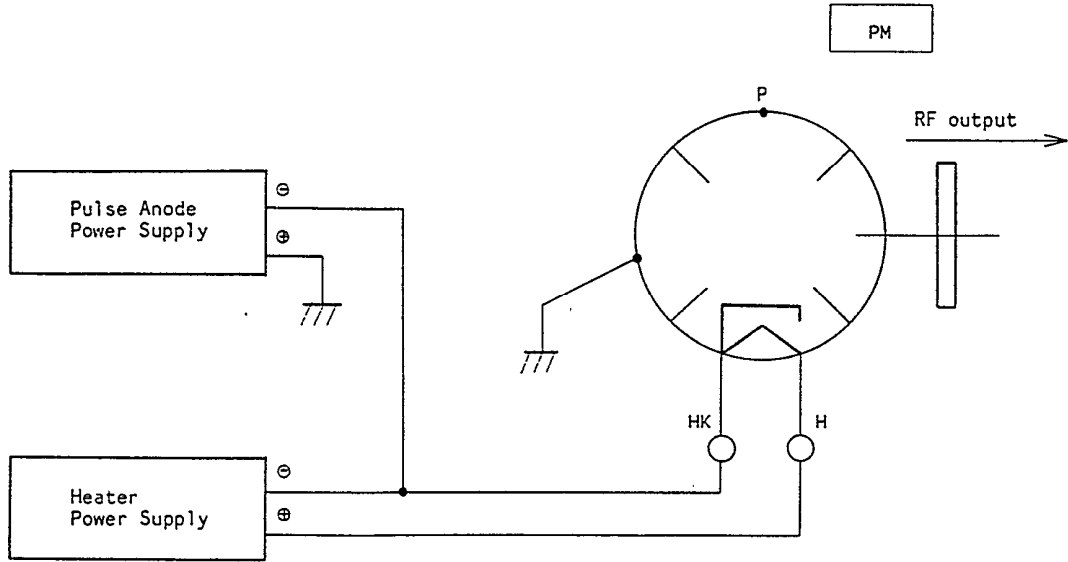

POWER SUPPLY CONNECTION



SAFETY PRECAUTIONS

Before operating the electron tube, be sure to read this operation manual carefully. This operation manual describes important information for preventing injury to users, personnel at manufacturers employing this electron tube, and other personnel, as well as for preventing property loss and for ensuring safe operation. Fully understand the meanings of the following indications and symbols before reading this manual and observe all precautions to ensure safe operation.



[Description of indications]

	Indication	Indication Meaning
	WARNING	Indicates a potentially hazardous situation which, if not avoided, could result in death or serious injury.
	CAUTION	Indicates a potentially hazardous situation which, if not avoided, may result in minor or moderate injury ^(*) or property damage ^(**) .

*1: The phrase "minor or moderate injury" means personal injury, burn, electrical shock, etc. that does not require inpatient medical care.

*2: The term "property damage" means extended damage such as damage to facilities or materials.

[Description of symbols]

Symbol	Meaning
	"DON'T" : Indicates a prohibition (something that you must NOT do). Details are described in words near the symbol.
	" DO " : Indicates a compulsion (something that you must do). Details are described in words near the symbol.

[Disclaimer]



- Toshiba will not be held responsible for associated damage (loss of business profits, interruption of business, etc.) resulting from the operation or non-availability of the equipment.
- Toshiba will not be held responsible for damage caused by natural calamities, fires, acts by the third parties, accidents, intentional or accidental mis-operation, and operation under abnormal conditions.
- Toshiba will not be held responsible for damage caused by non-observance of the ratings of this equipment.
- Toshiba will not be held responsible for damage caused by malfunctions of the system in which this equipment is incorporated.



[Restrictions on use]



<p>■ This equipment is not designed or manufactured for use in combination with systems that include components that directly affect the maintenance or loss of human life (*1). Do not use this equipment for such systems.</p> <p style="padding-left: 40px;">*1 : Systems/equipment directly affecting the maintenance or loss of human life include the following:</p> <p>■ Life-support systems, surgical equipment, and diagnostic equipment</p> <p>If this equipment is used in combination with systems (*2) that are related to public safety or maintenance of essential public services, special procedures (*3) are required for the operation, maintenance, and management of the systems. Contact Toshiba in advance.</p> <p style="padding-left: 40px;">*2 : Systems related to public safety or maintenance of essential public services include the following:</p> <ul style="list-style-type: none"> • The main control systems of nuclear power plants, safety protection systems for nuclear facilities, and other important systems for safety • Mass-transit and air traffic control systems <p style="padding-left: 40px;">*3 : Special procedures refers to the development of safe systems (fool-proof, fail-safe, and advanced design, etc.) in close cooperation with Toshiba engineers.</p>

[Manufacturing, installation, and operation of the equipment]

The manufacturing, installation, and operation of systems which incorporate this equipment and transmit electromagnetic waves should be performed in compliance with all applicable regulations related to electromagnetic waves.

 <p>WARNING</p>	
 <p>"DO NOT DISASSEMBLE"</p>	<p>■ Do not disassemble, modify, or repair the equipment. There is danger of irradiation, fire, electric shock, or burns due to high-frequency electromagnetic waves.</p>
 <p>DOs</p>	<p>■ Provide a protective fence preventing contact with the high-voltage section. If you approach or touch the electrode section or lead wires while power is supplied, there is danger of death or injury due to electric shock. The protective fence should be equipped with safety switches that shut down the high-voltage power supply as soon as a door or panel is opened.</p> <p>■ Install the waveguide and output flange sections securely, so as to prevent electromagnetic wave leakage. There is danger of irradiation, fire, or burns due to high-frequency electromagnetic waves.</p>

	 WARNING
 DOs	<ul style="list-style-type: none"> ■ Keep the area around the equipment free of flammable materials and keep the equipment free of dust. Otherwise, there is danger of fire. ■ Provide an X-ray protective barrier if an X-ray dose exceeding 77.4 μ c/kg-hr is output. Otherwise, there is danger of X-ray exposure and the consequent health-related problems. The protective barrier should be equipped with safety switches that shut down the high-voltage power supply as soon as a door or panel is opened. ■ Provide a safety device which prevents over-currents due to shorting between the electrode terminals etc. Otherwise, the connection cables may be heated and there is danger of fire. ■ Before performing preventive maintenance work, turn OFF the power and perform grounding of each electrode to enable discharge. Otherwise, there is danger of death or injury due to electric shock. ■ When a magnetron incorporating a permanent magnet is to be transported by air, observe the restrictions specified in the special packing standard (IATA packing standard 902).
 DON'Ts	<ul style="list-style-type: none"> ■ Never supply high voltage when the high-frequency load (output waveguide) is not connected to the high-frequency output section. ■ Do not look into the waveguide, the antenna, or the edge section of the co-axial cable during operation. Doing so may result in loss of eyesight due to exposure of the eyes to high-frequency electromagnetic waves. ■ Persons with cardiac pacemakers must not engage in manufacturing, operation, or preventive maintenance of the equipment. There is danger of abnormal operation of cardiac pacemakers.

 CAUTION	
 DON'Ts	<ul style="list-style-type: none"> ■ Do not lift or carry objects with a weight of more than 20 kg on your own. Otherwise, there is danger of back injury during lifting or injury due to falling. During carrying-in and installation, use suitable lifting/carrying-in equipment or enlist the help of others when carrying heavy objects. ■ Do not drop the equipment or subject it to shocks. The electron tube may break or explode and there is danger of injury. Wear gloves and a protective mask during carrying-in and installation. When the electron tube is disposed of, inform the disposal technicians of the danger of explosion. ■ Do not touch the main body or peripheral parts during operation or immediately after operation is stopped. There is a danger of burns due to high temperatures. ■ Do not allow any permanent magnets or magnetic objects to come near the electron tube. They will be attracted by the magnetic field, possibly resulting in personal injury or damage to the electron tube. ■ Do not place magnetic cards, floppy disks, etc. near the electron tube. There is a danger of breakdown of the data.
 DOs	<ul style="list-style-type: none"> ■ When handling a tube that has fractured, wear protective gloves, protective glasses, etc. because the ceramic or metal fragments are sharp and very dangerous. ■ Used electron tubes must be disposed of by specialized waste disposal personnel. Toshiba will assist in the disposal of used electron tubes. Please contact Toshiba to make suitable arrangements. Note that Toshiba will not be held responsible for arrangements and costs prior to arrival at Toshiba. <p>*The main materials used in this electron tube are as follows:</p> <ul style="list-style-type: none"> ·Metals(copper, nickel, silver, stainless steel, iron, nickel/iron alloy, aluminum, tungsten,), Cast magnet(Al, Ni, Co, Ti, Cu, Fe), Alumina-ceramics, Electric-wire, Insulated-plastic. <p>Note that no radioisotopes or beryllia porcelain are used.</p>

PROTECTION DEVICE REQUIRED

- (1) The magnetron should be taking care to handle by the mine body and not by the leads wires. There are damage of breakage of the cathode structure.
- (2) The magnetic field of the magnetron has been precisely adjusted. To prevent interaction between magnets and magnetic objects, and some permanent demagnetization, do not allow any permanent magnets or magnetic objects to come near the magnetron. When the magnetrons are unpacked, e.g. at assembly line for installation purposes, care should be taken that a minimum distance of 25mm is maintained between the tubes, never should be placed directly on any magnetic materials (steel shelf, etc.). Non-magnetic tools must be used for installation. When the tube is stored. The best protection of the tube is the Toshiba standard packing.
- (3) Be careful not to subject the magnetron to excessive vibration or mechanical shock because it is a precision device. Use the Toshiba standard packing box to carry or store the magnetron.
- (4) The magnetron must be Stored in a dry location (relative humidity < 60%). Do not store this product in a location where the temperature or humidity may change rapidly because condensation may form on the surface of the magnetron.