

Section 12. Circuit Diagram

- 12.1 CDE-783 Panel
- 12.2 CAF-412 TX/RX Unit
- 12.3 CGH-192 Synthesizer Unit
- 12.4 CAH-449-D PA Unit
- 12.5 CFJ-157 LPF Unit
- 12.6 CFG-127 Matching Unit (JST-245, standard; JST-145, optional)
CCB-424 RL-Control Unit (JST-245, standard; JST-145, optional)
- 12.7 CCC-284 Sensor Unit (JST-245, standard; JST-145, optional)
- 12.8 CCL-265 ANT Switch Unit
- 12.9 CDC-796 CPU Unit
- 12.10 CCL-227 Tone Unit (Optional)
- 12.11 CMF-144 Monitor Unit (Optional)
- 12.12 JST-145 Overall Connection Diagram
JST-245 Overall Connection Diagram

11.2 Synthesizer Flow

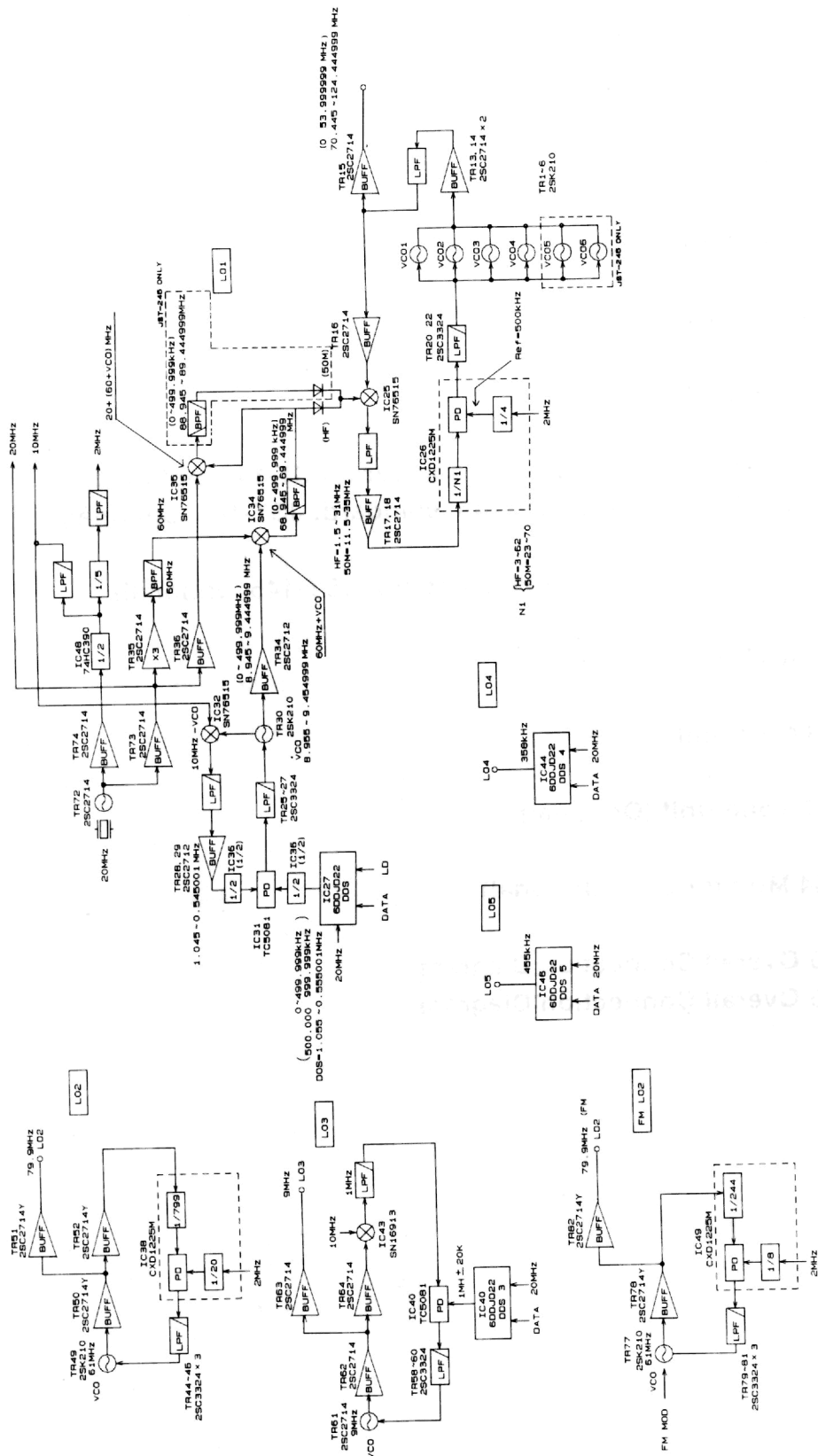

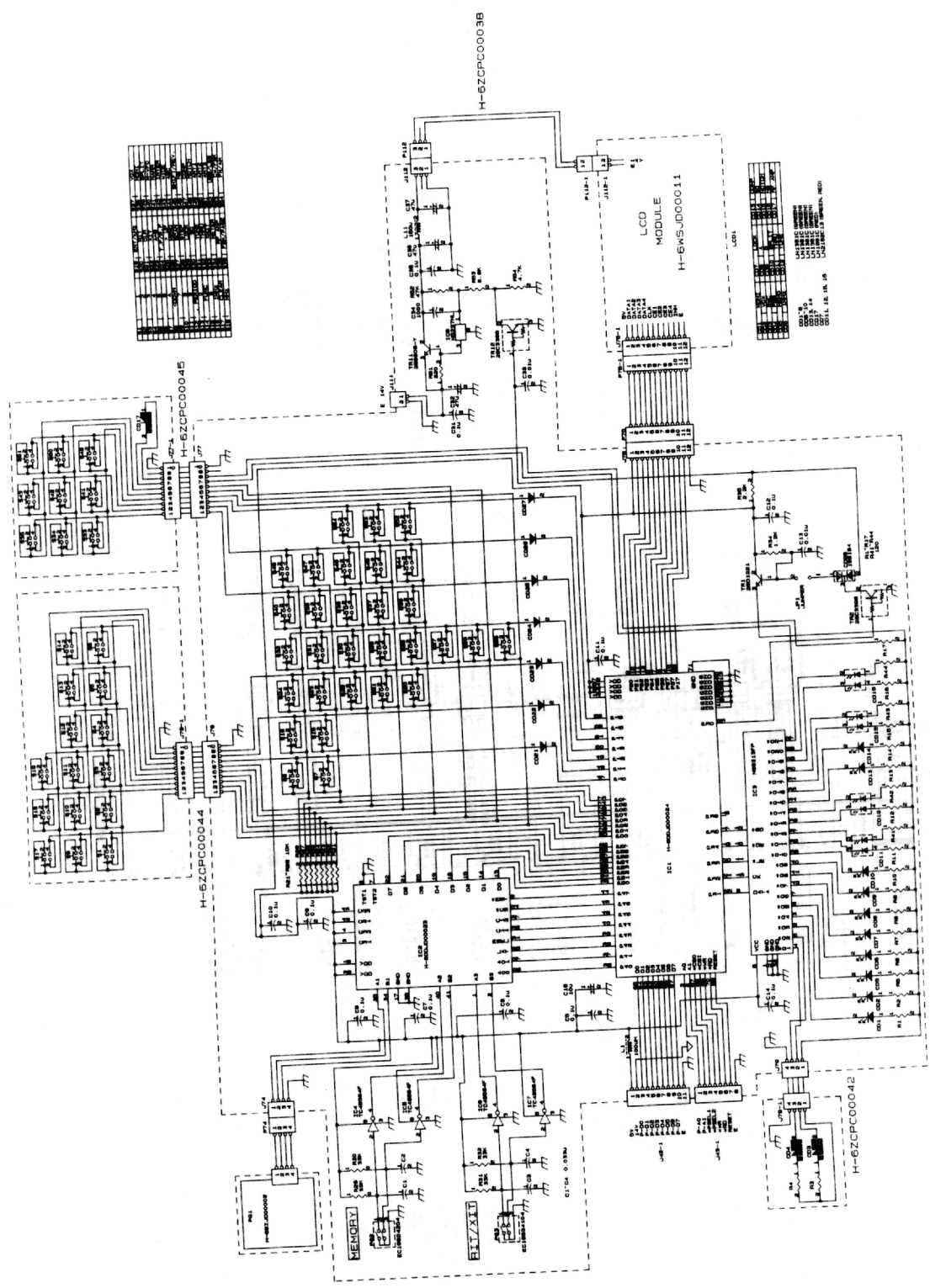

Section 12. Circuit Diagram

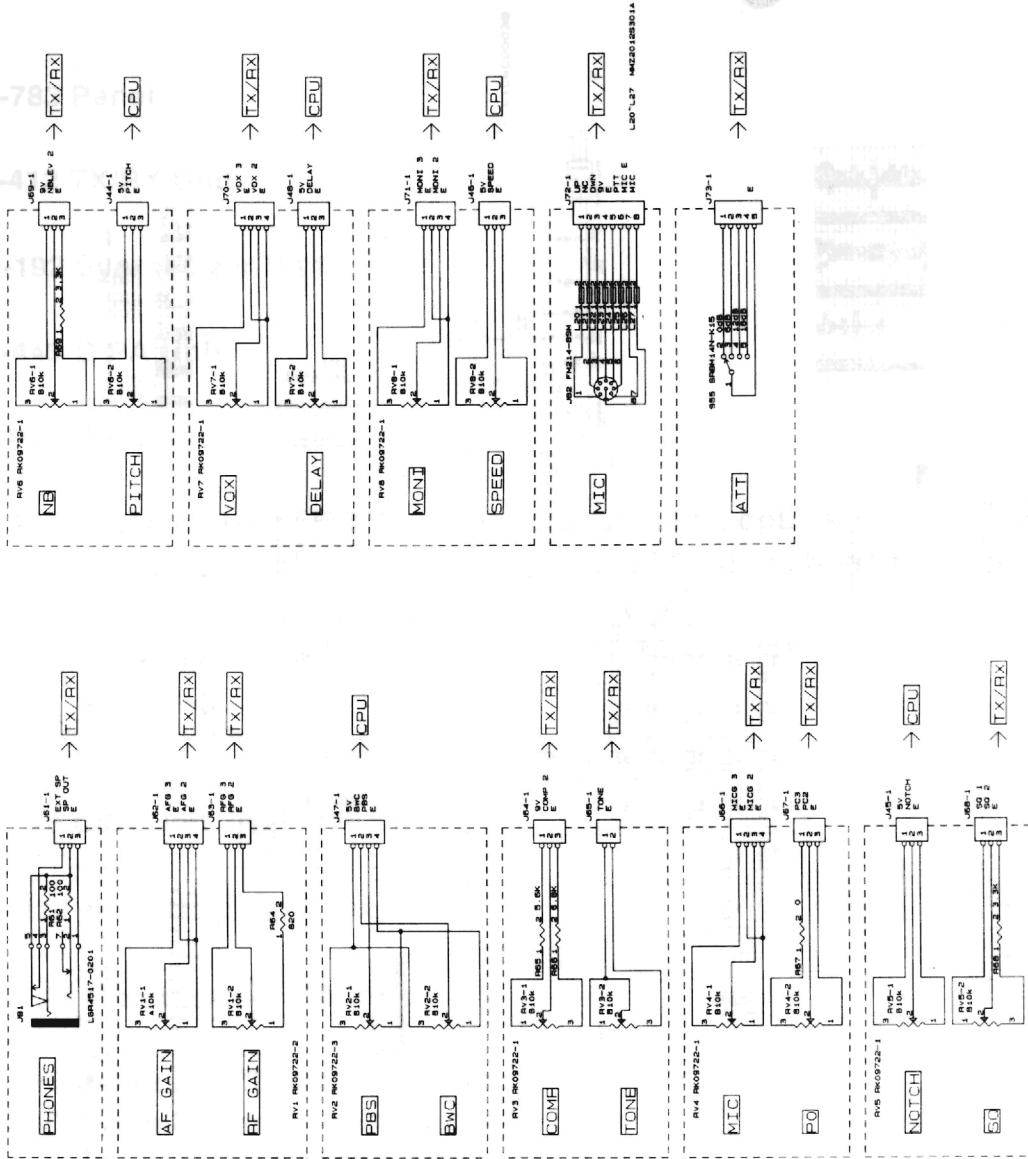

12.1 CDE-783 Panel (2/2)

12.2 CAF-4

12.3 CGH-19

12.4 CAH

12.5 CFJ

12.6 CFJ

12.7

12.8

12.9

12.2 CAF-412 TX/RX Unit (1/4)

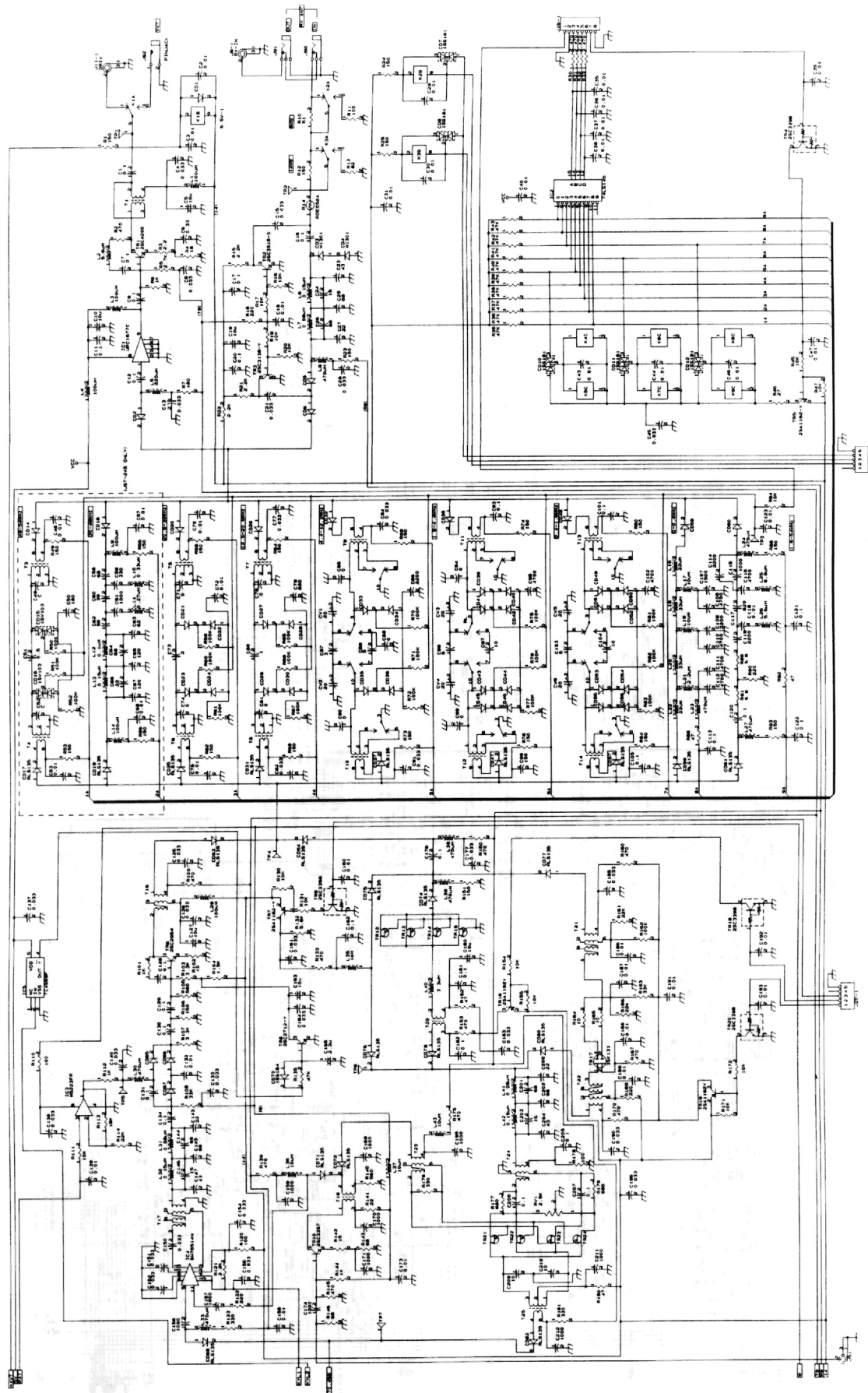

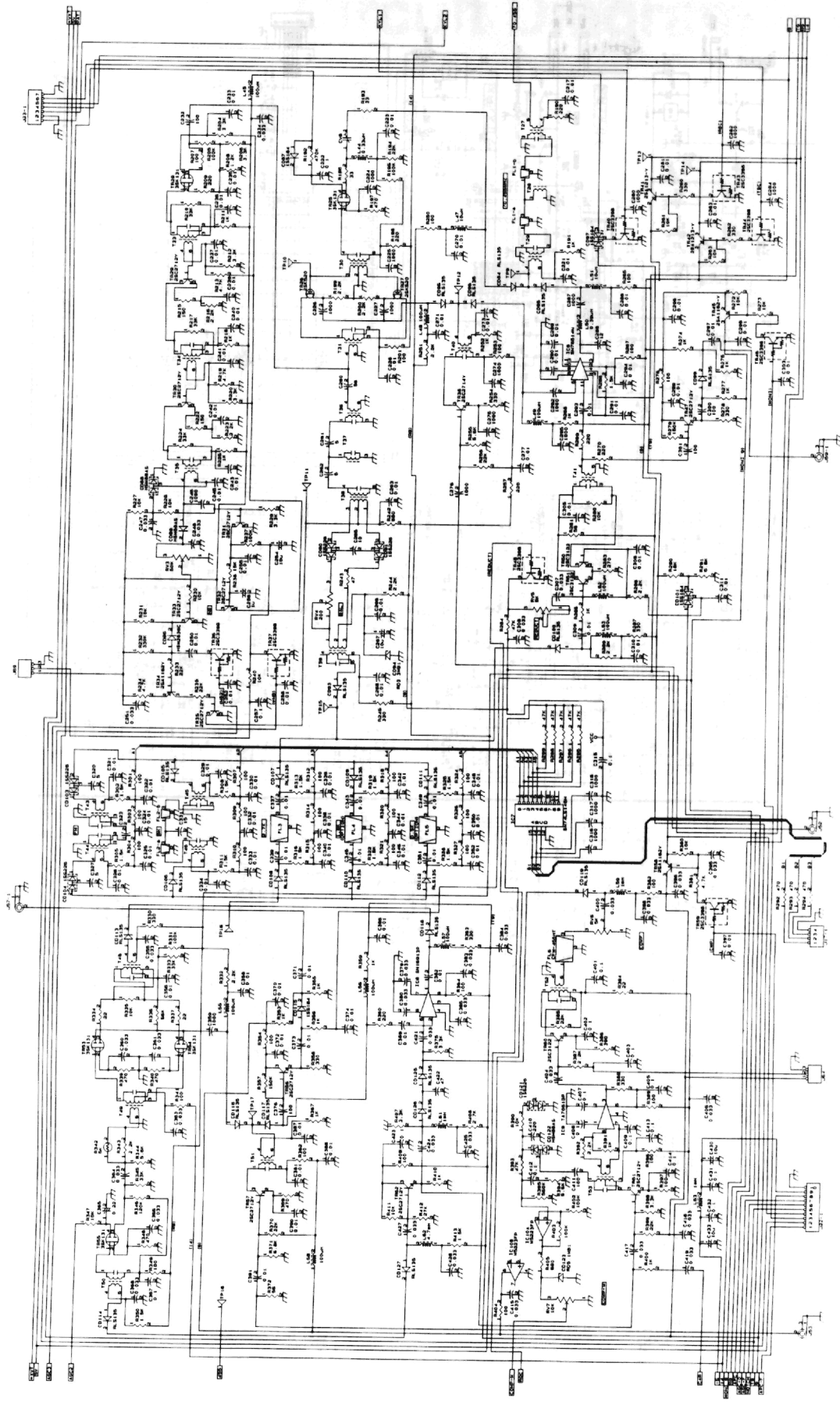

12.2 CAF-412 TX/RX Unit (3/4)

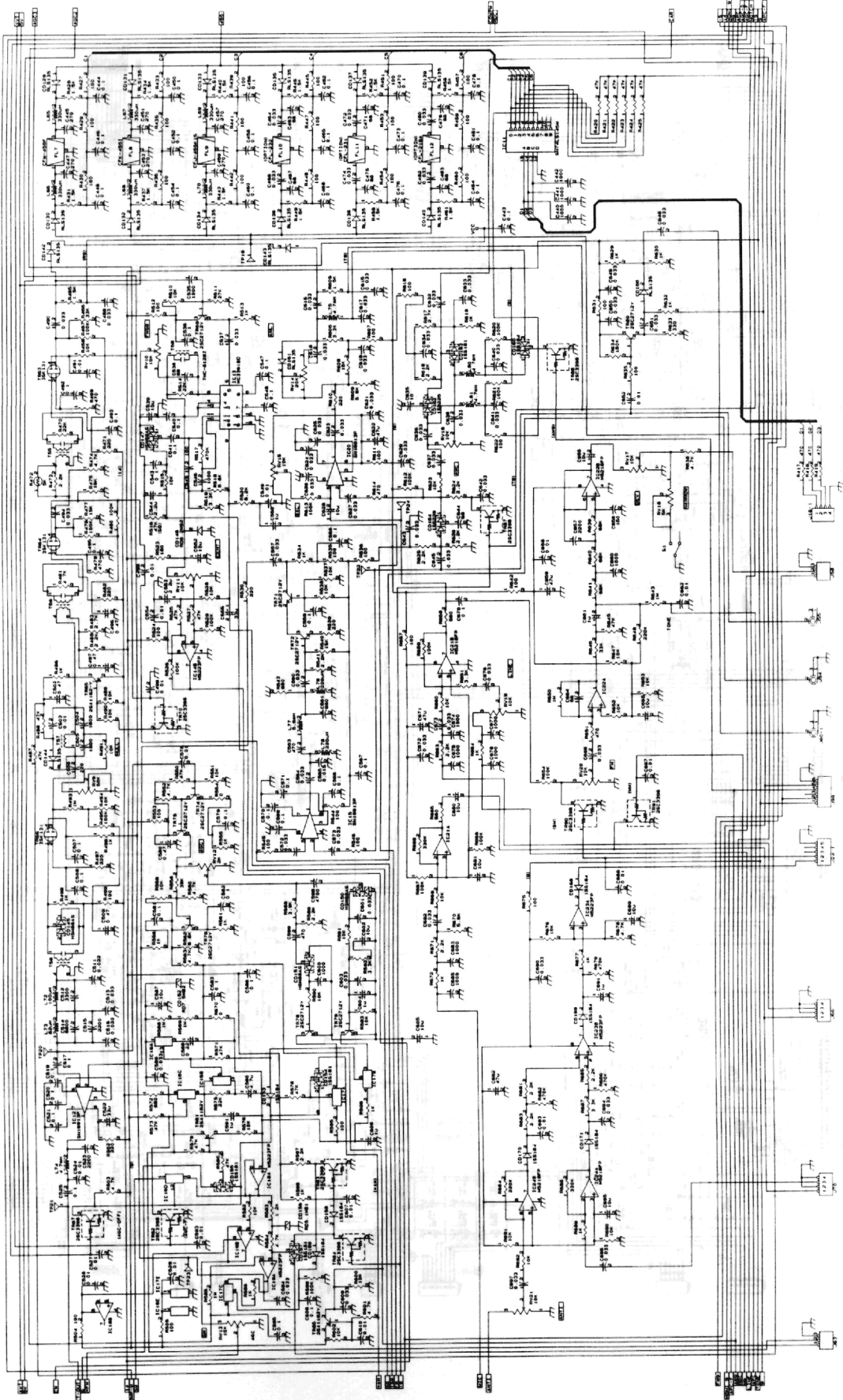

12.2 CAF-412 TX/RX Unit (4/4)

CAF-412 TX/RX Unit (3M)

25

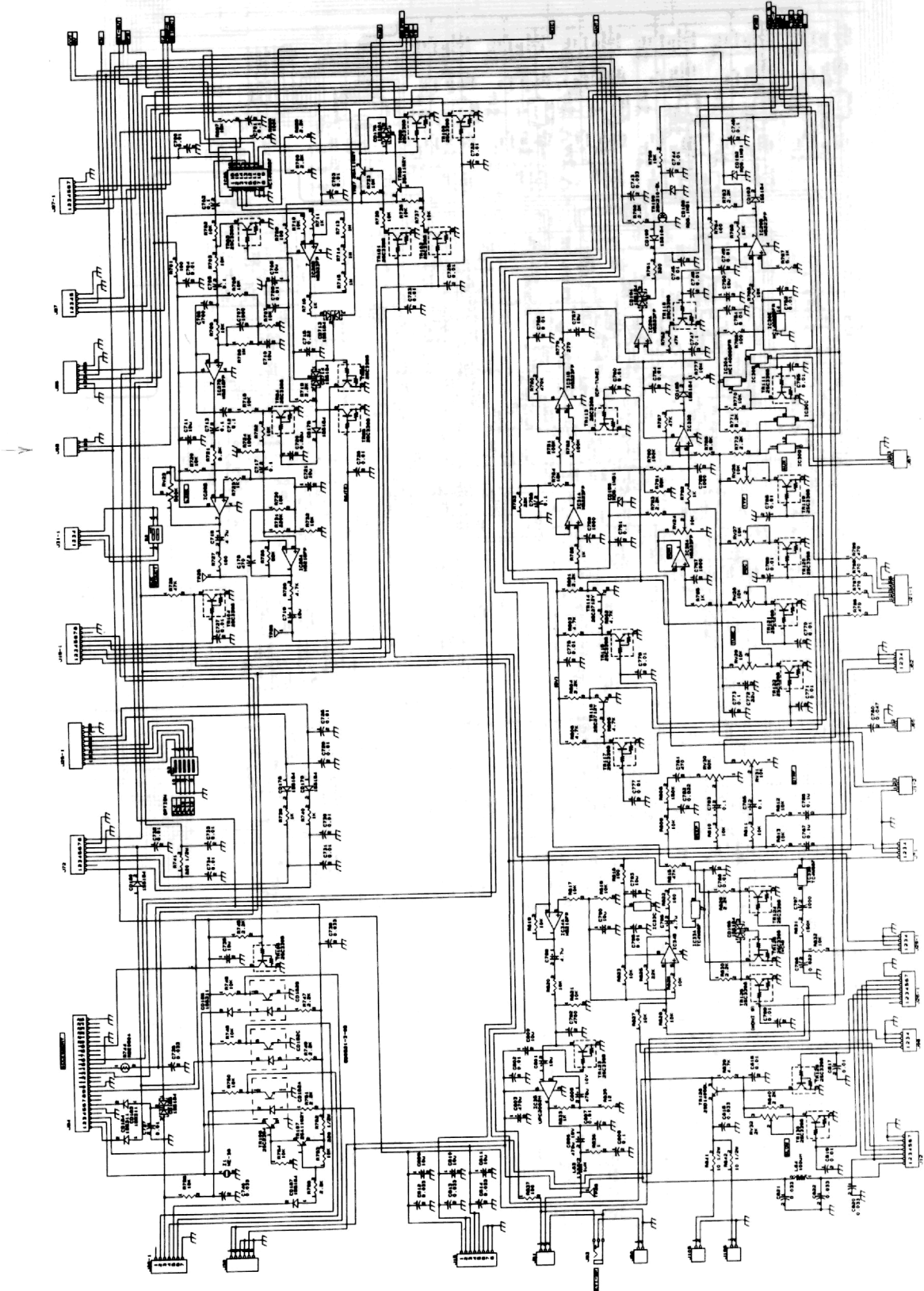

12.3 CGH-192 Synthesizer Unit (1/3)

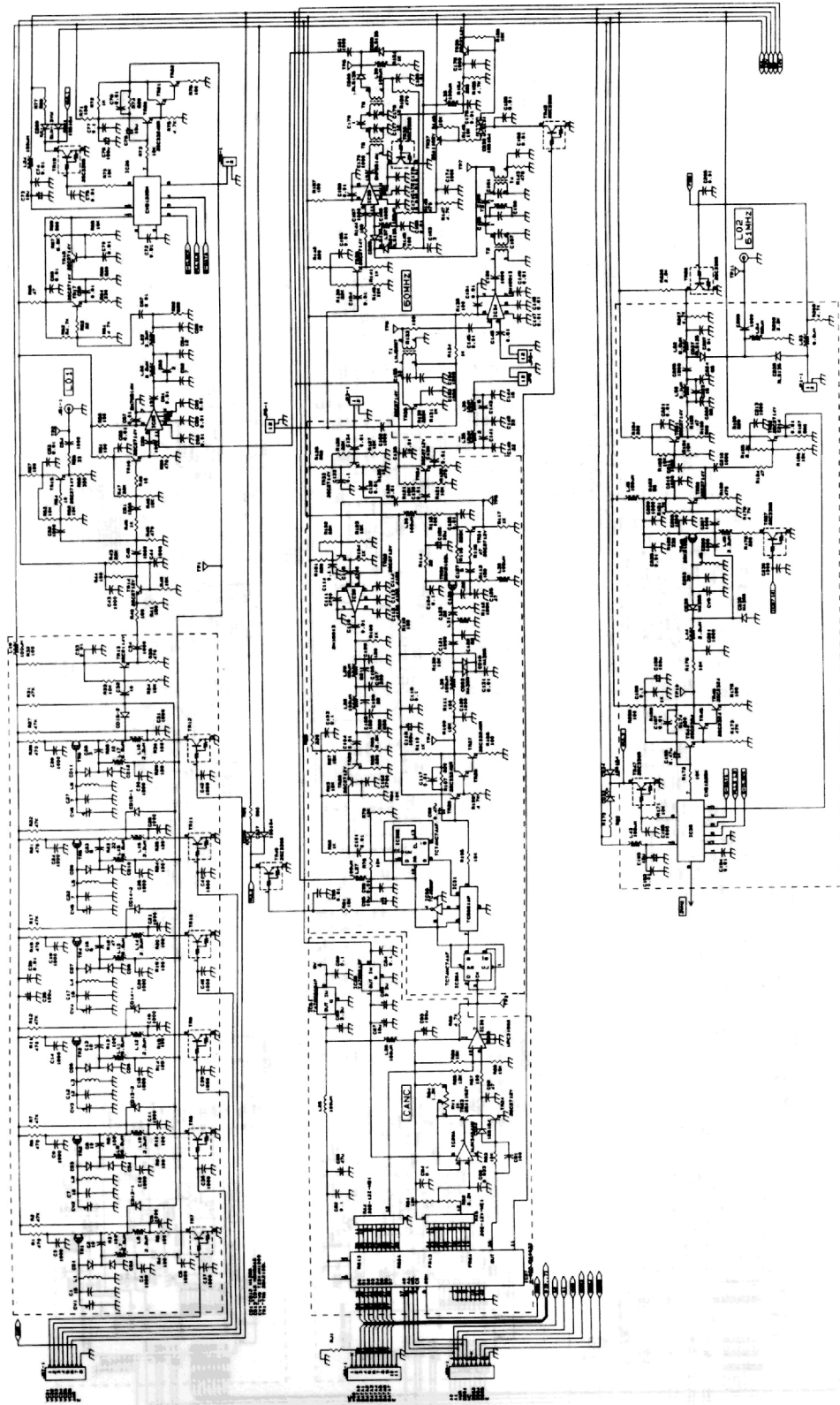

12.3 CGH-192 Synthesizer Unit (2/3)

12.3 CGH-192 Synthesizer Unit (1/3)

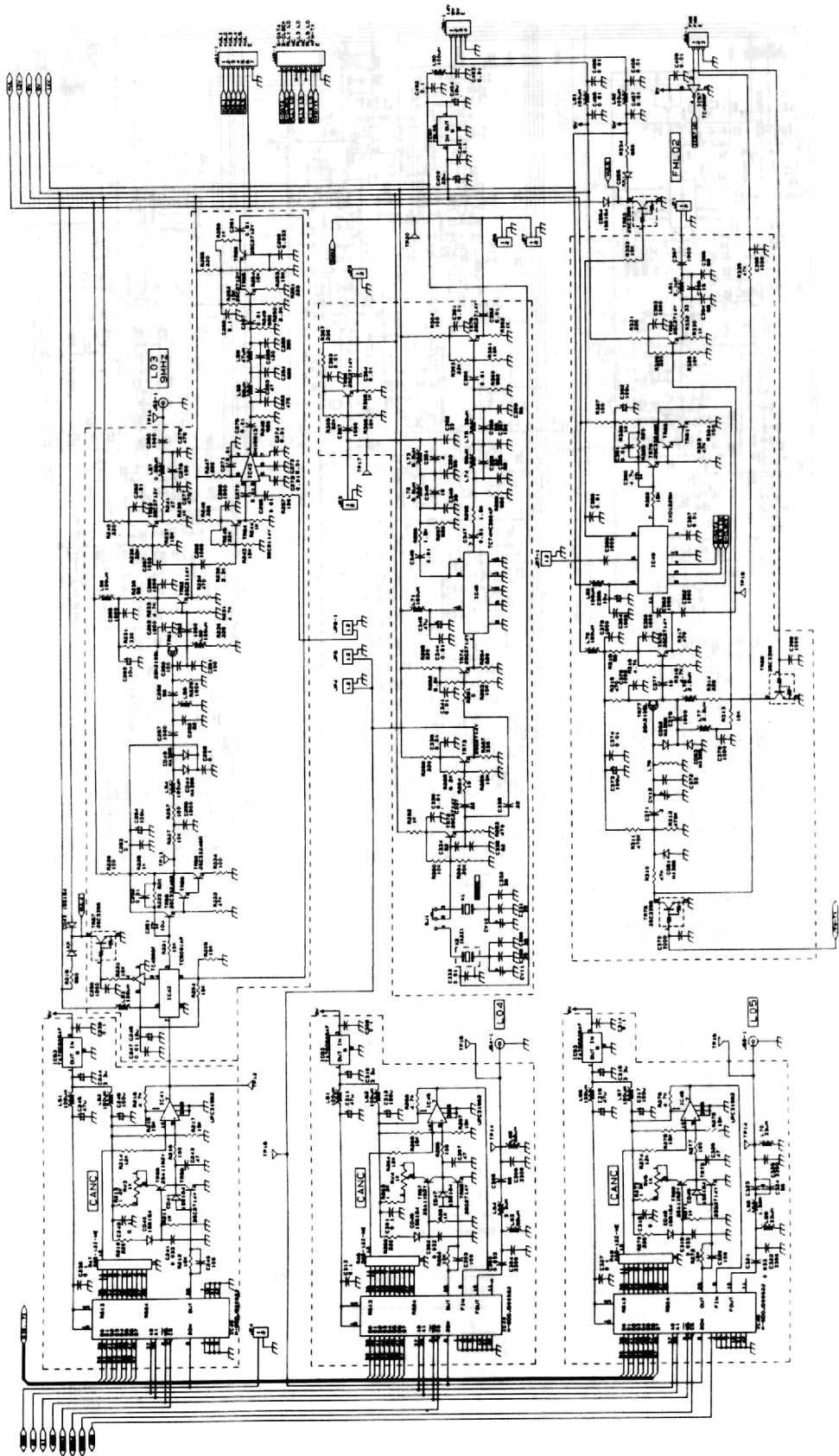

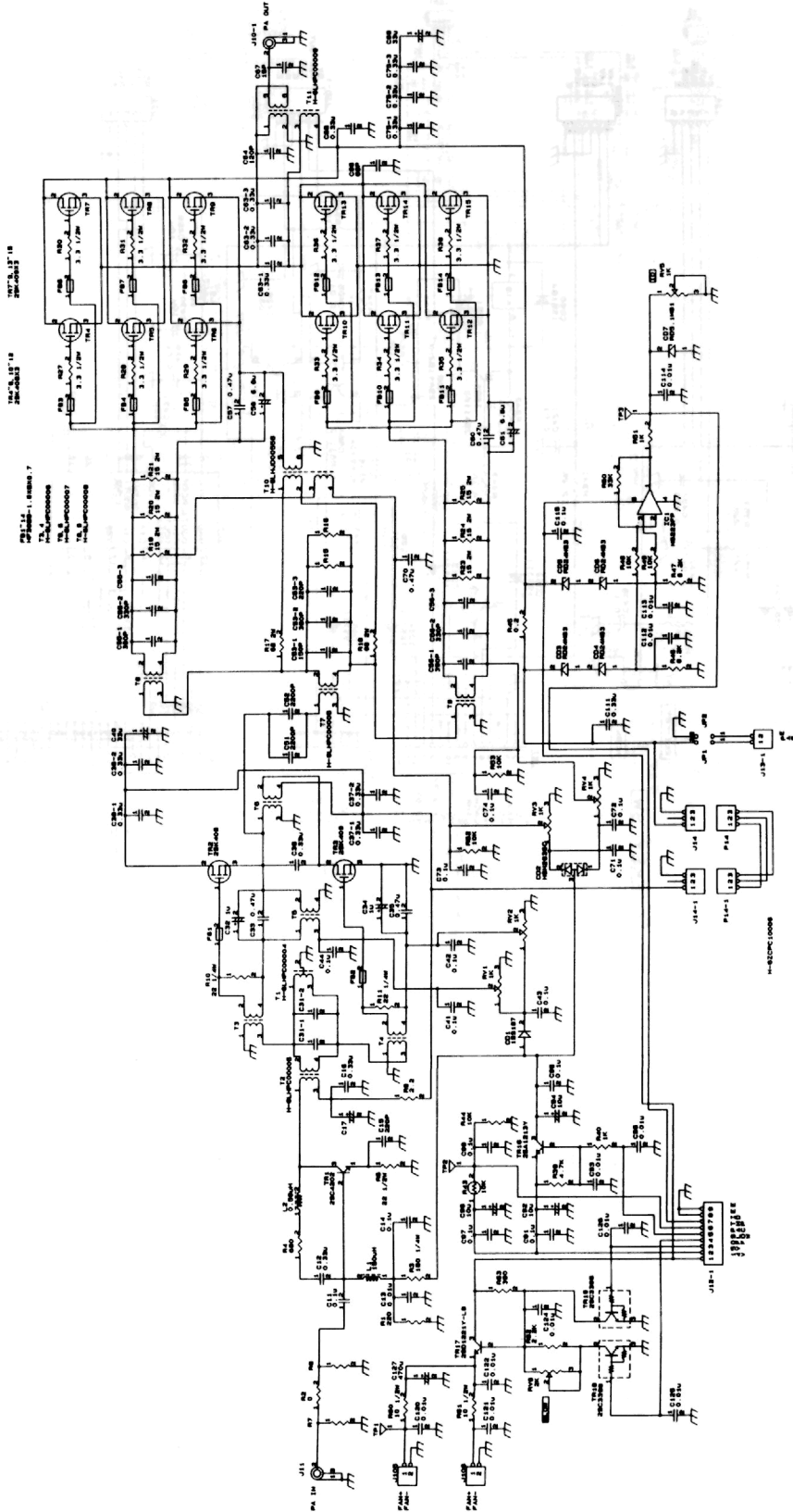

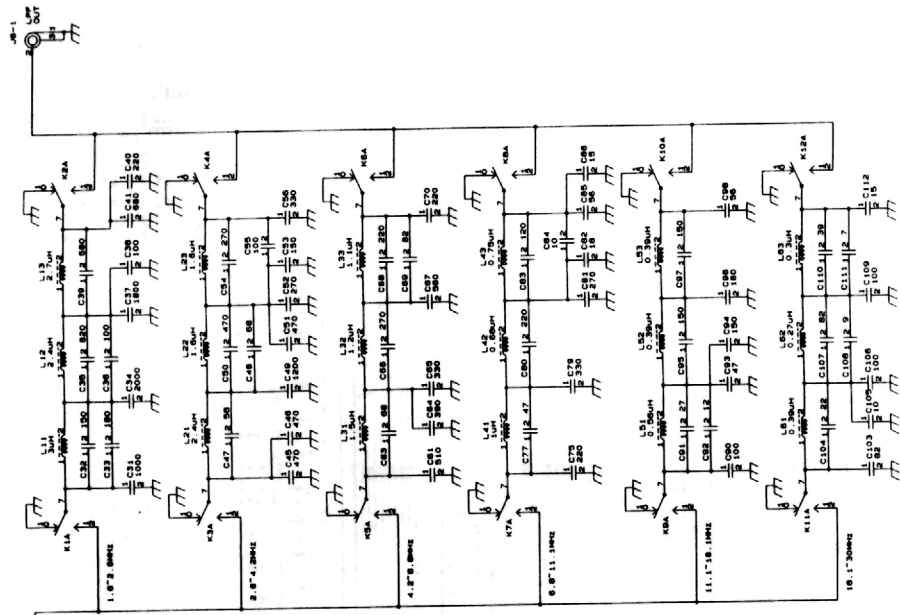

H-SPC_000884
H-SPQ_000157

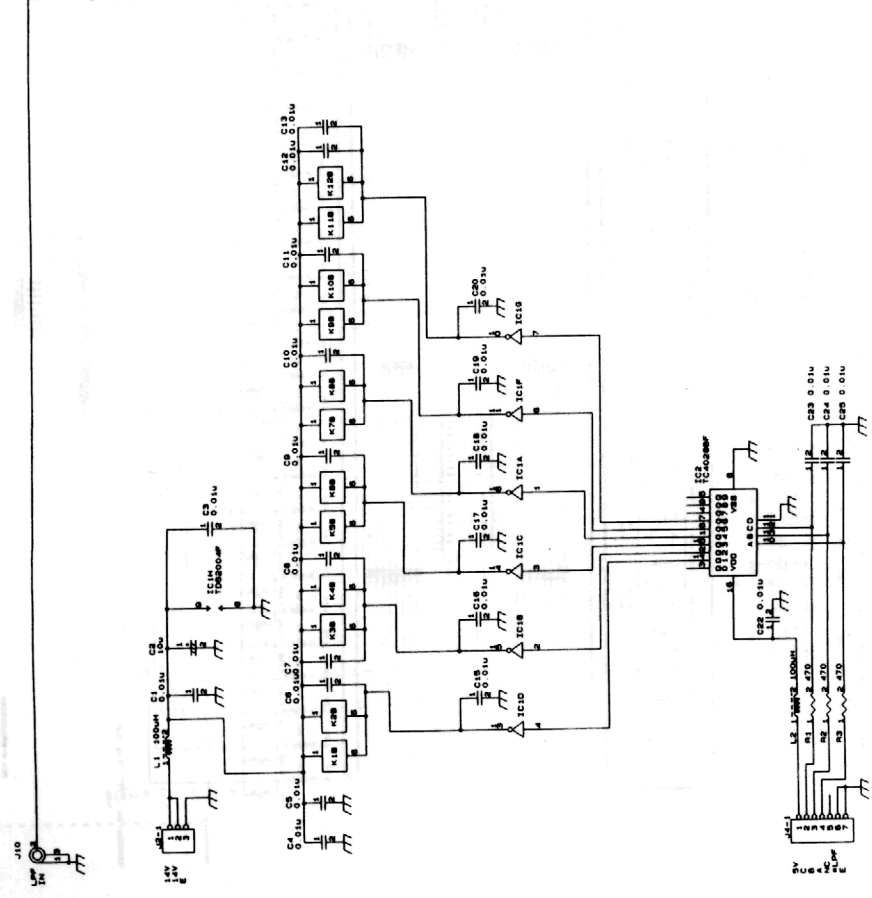

12.7 CCC-284 Sensor Unit (JST-245, standard; JST-145, optional)

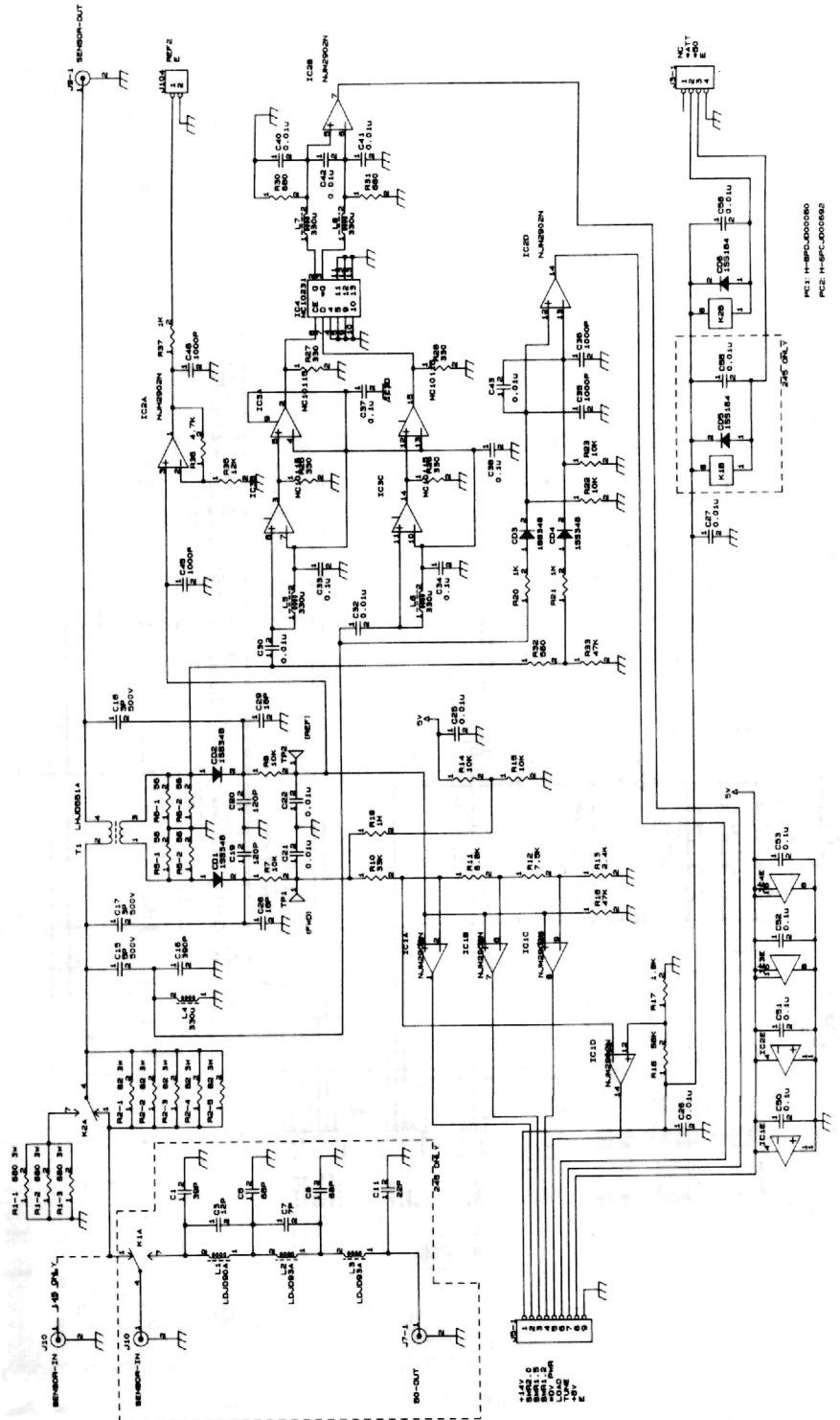

PC1: H-SP-00000080
PC2: H-SP-00000082

12.8 CCL-265 ANT Switch Unit

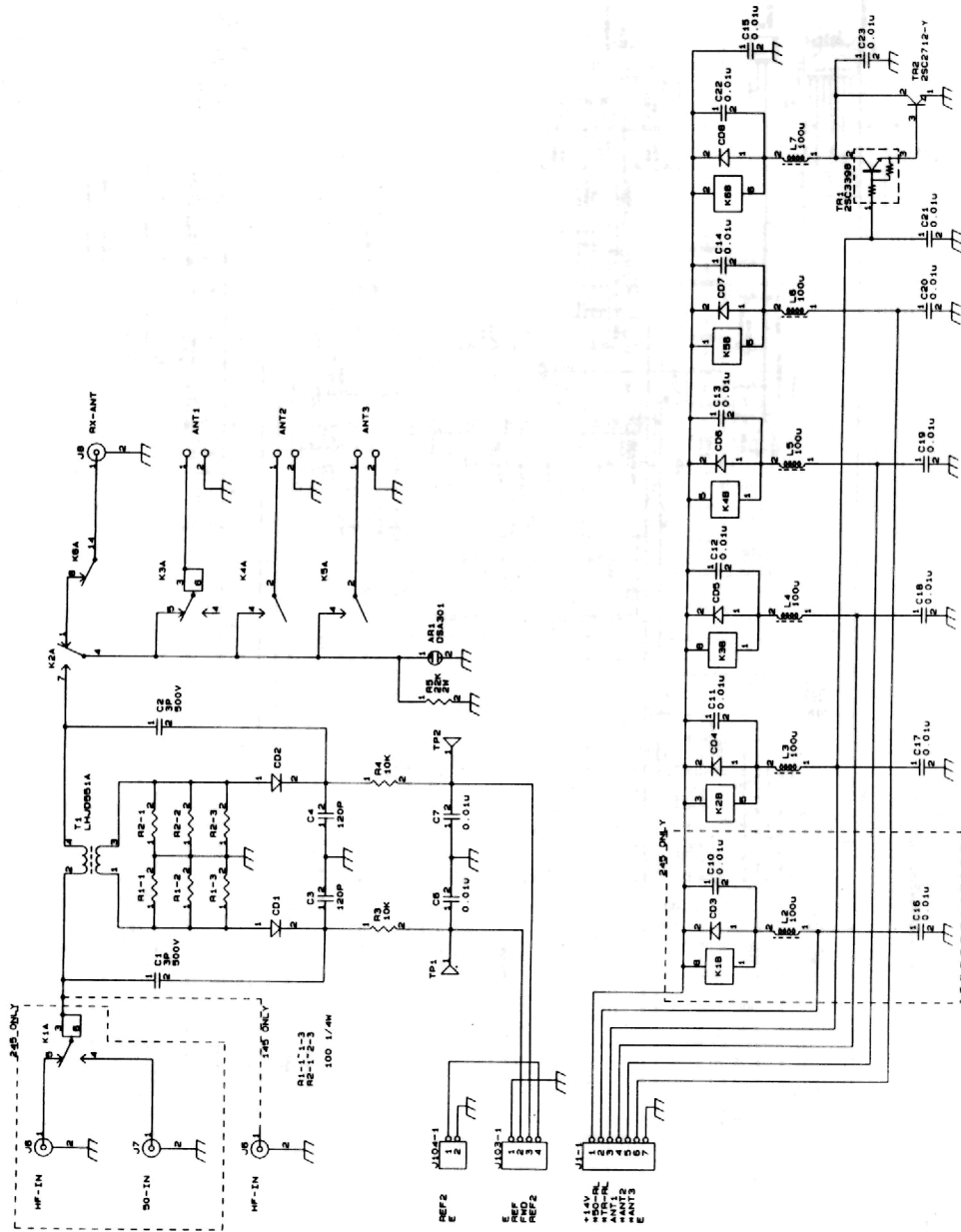

PC1: H-SFD-000061
PC2: H-SFC-000691

CD1: CD2 155346
CD3: CD8 155184

REF2
E
REF
REF2
E
+14V
-50V-RL
ANT1
ANT2
ANT3
E

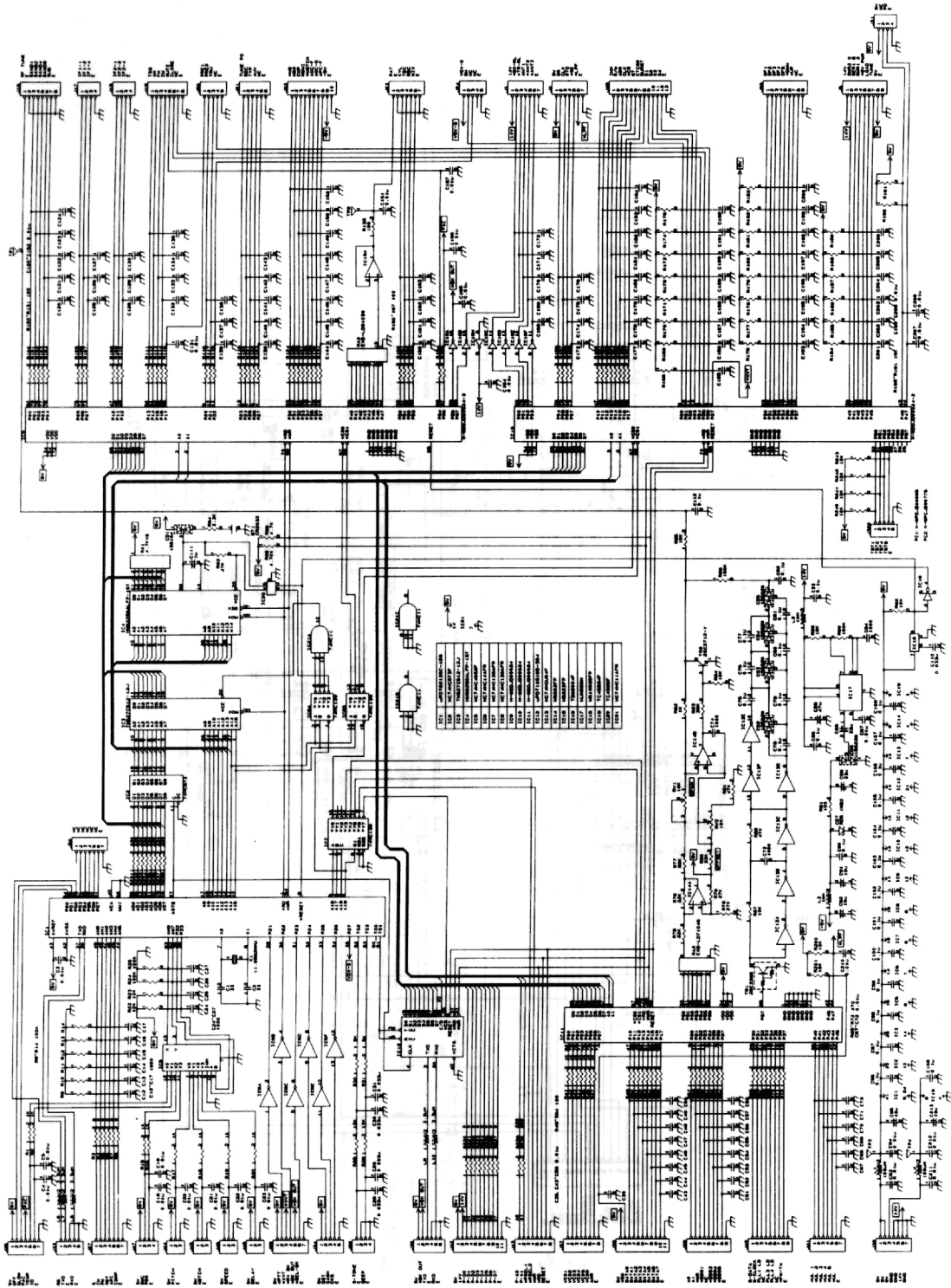

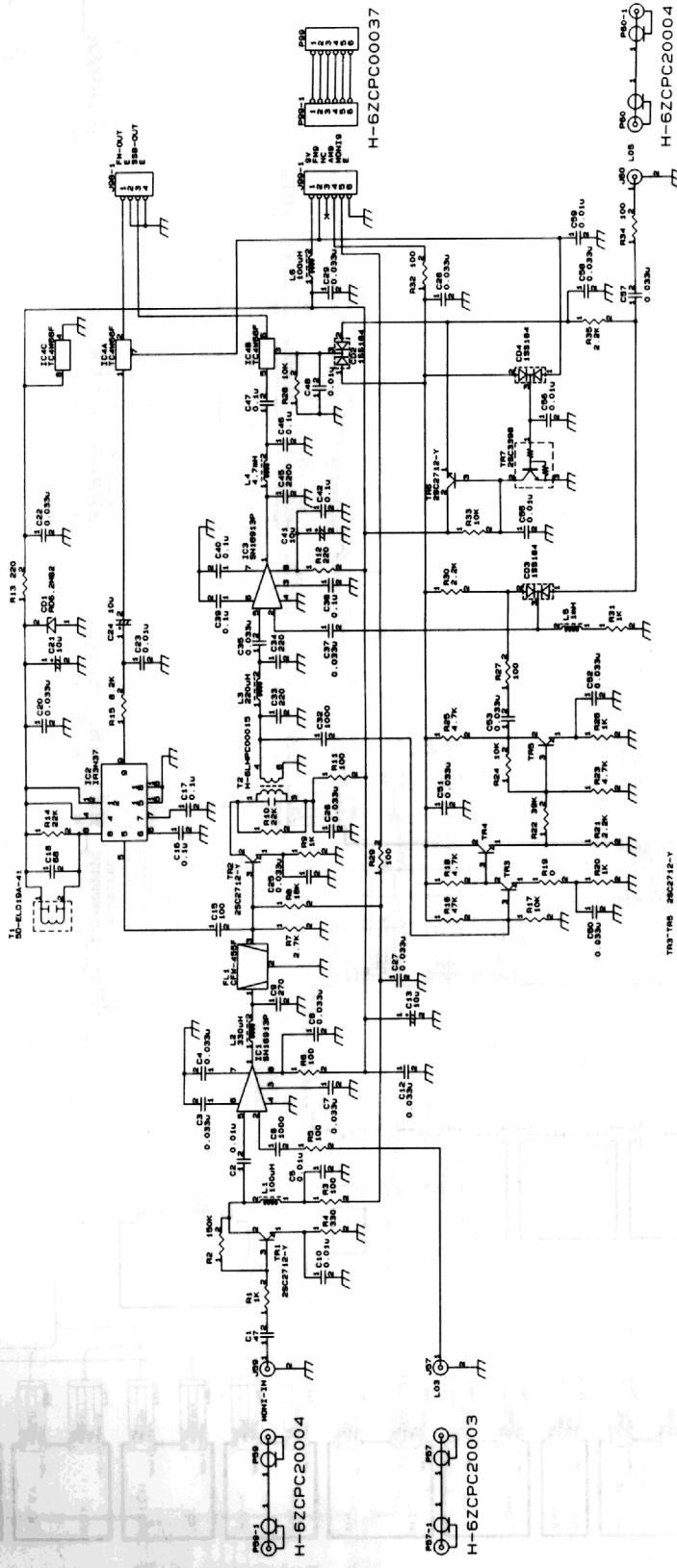

12.12 JST-145 Overall Connection Diagram (1/3)

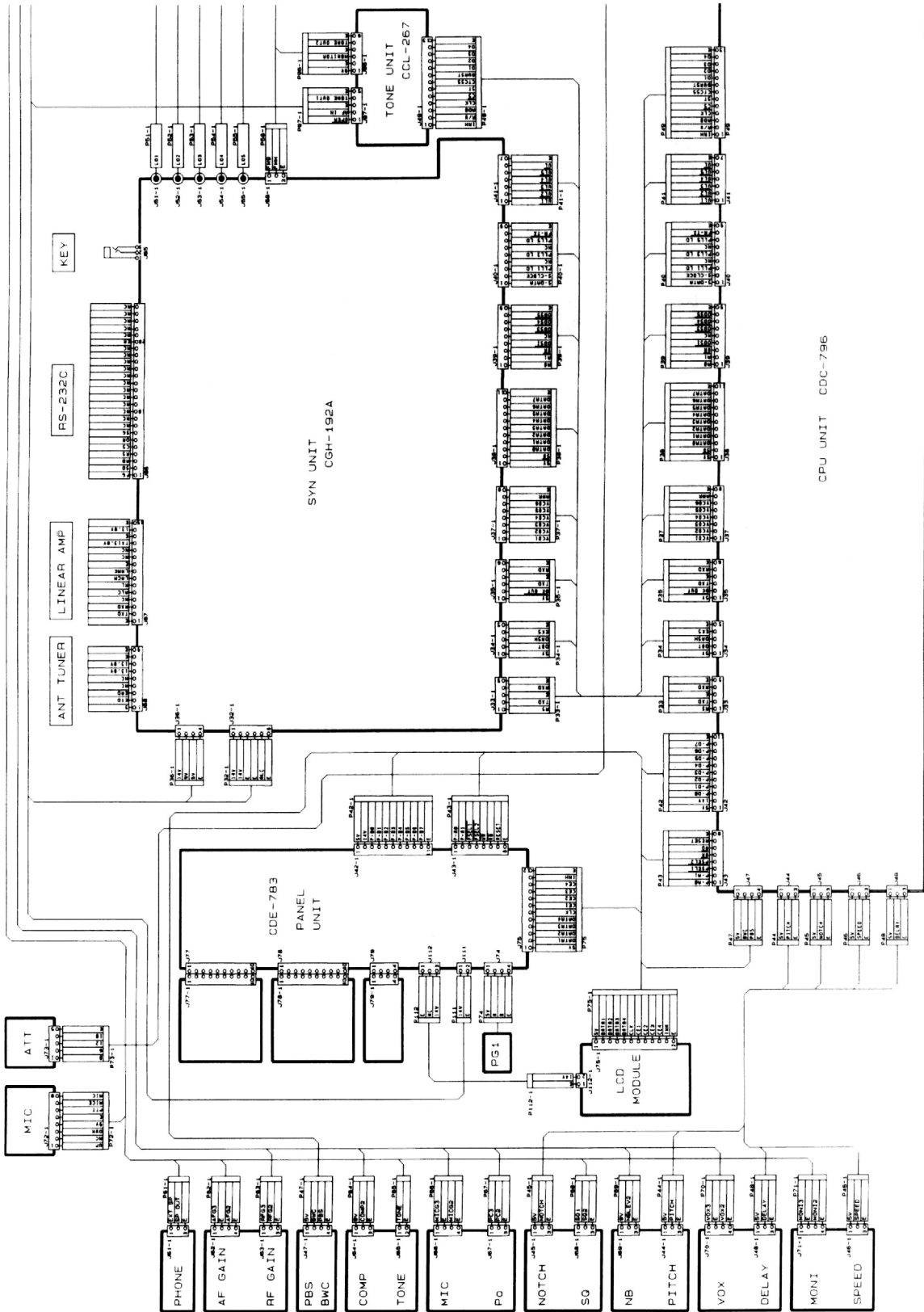

12.12 JST-145 Overall Connection Diagram (2/3)

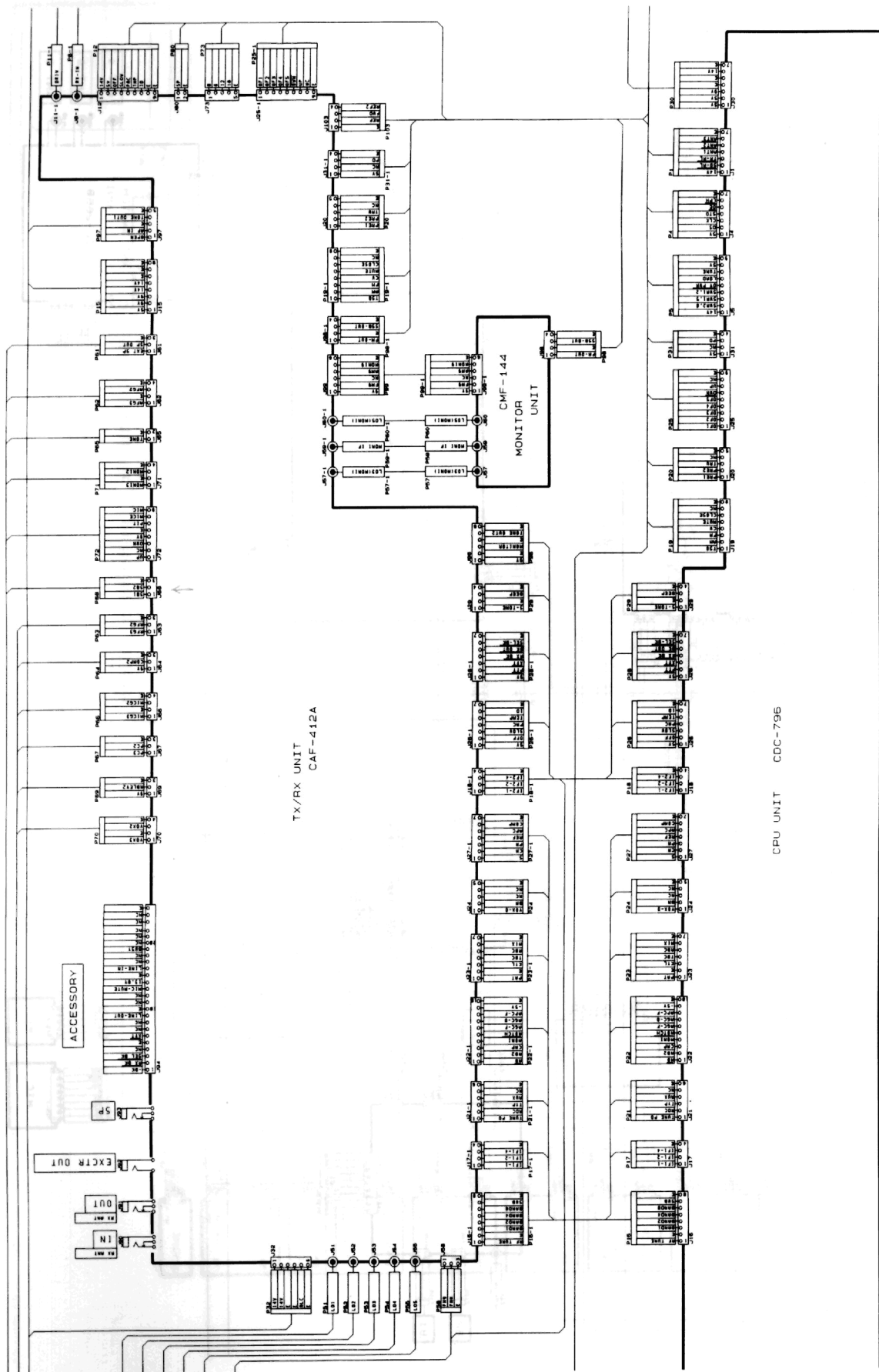

12.12 JST-145 Overall Connection Diagram (3/3)

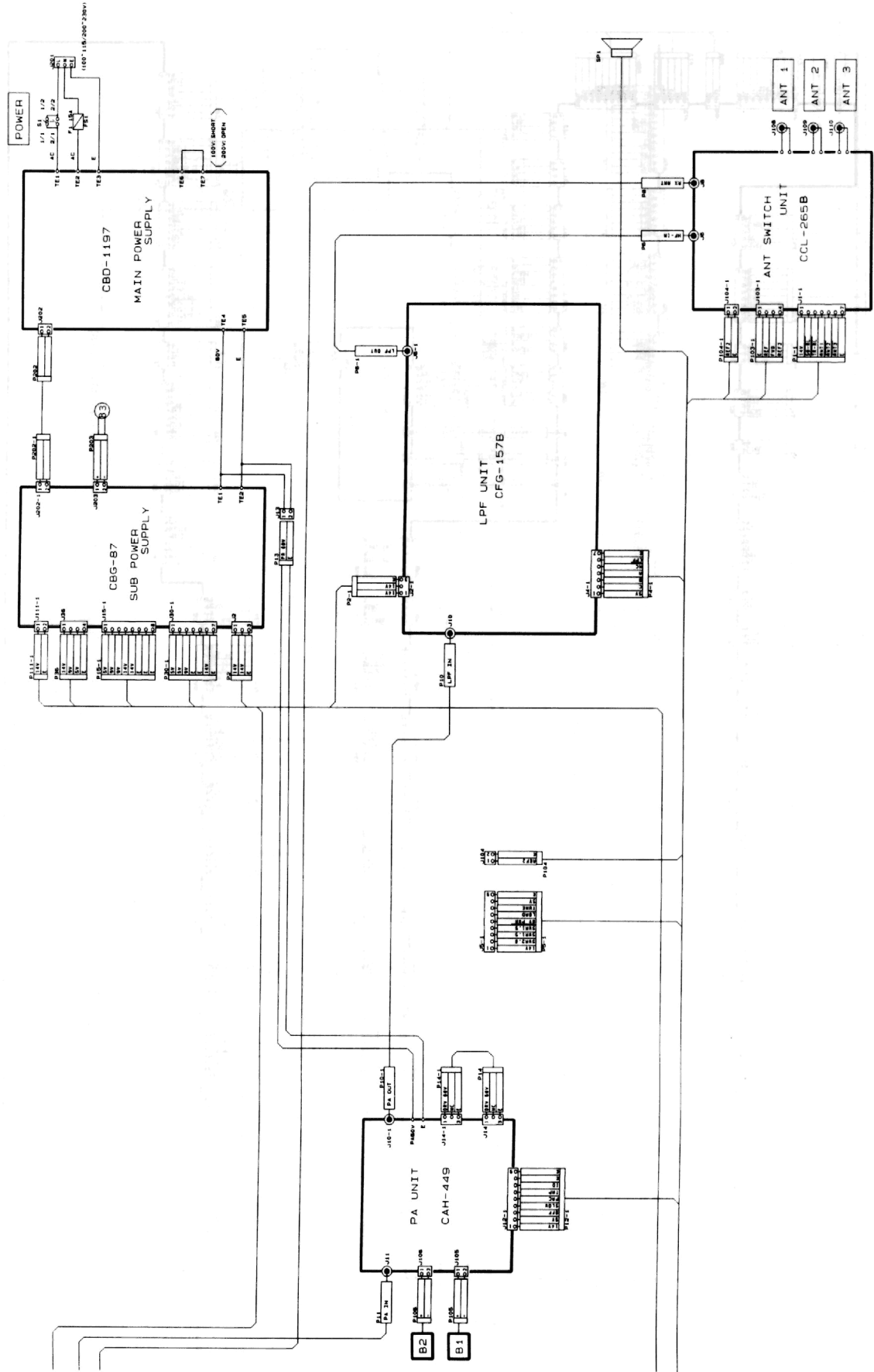

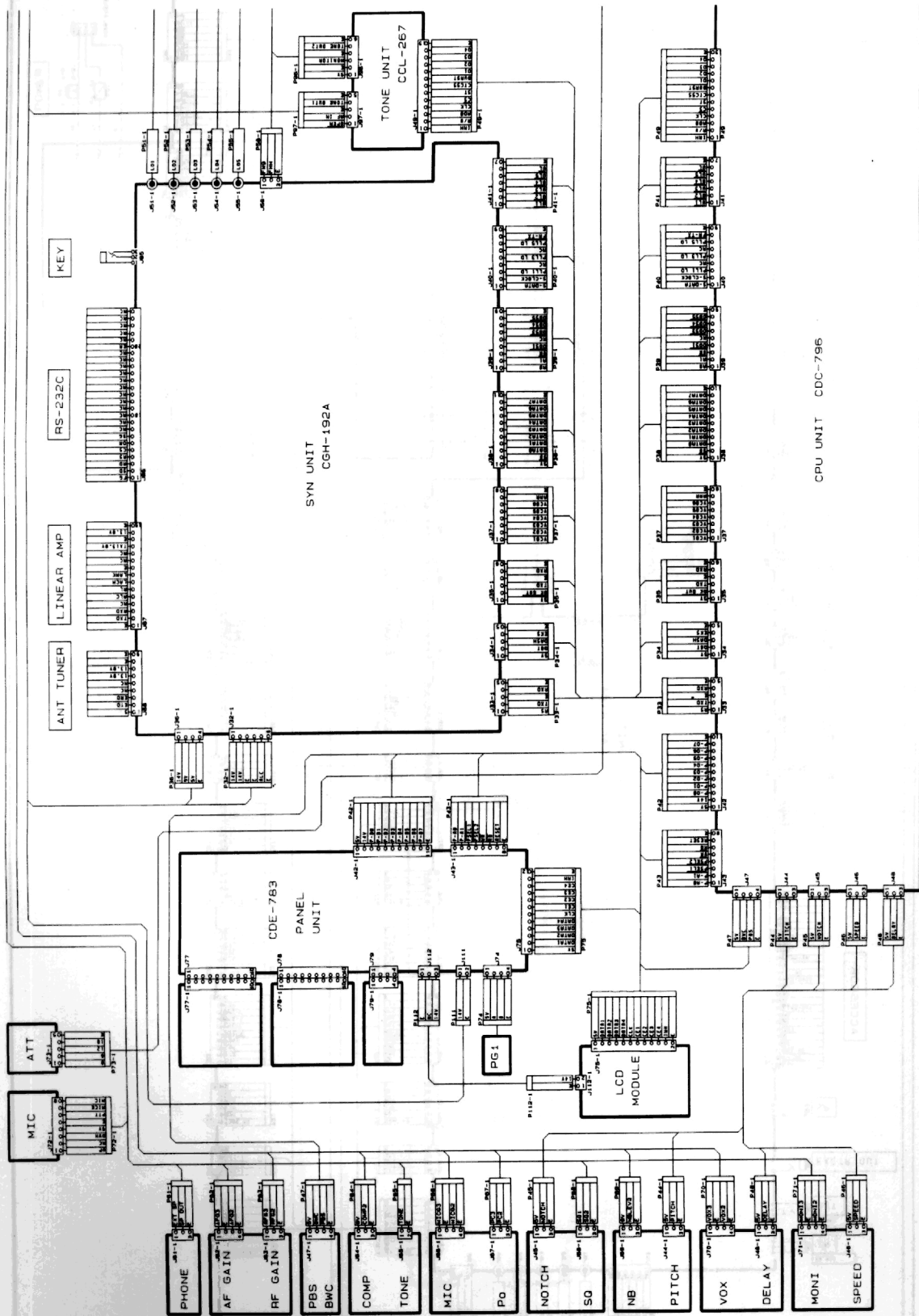

12.12 JST-245 Overall Connection Diagram (2/3)

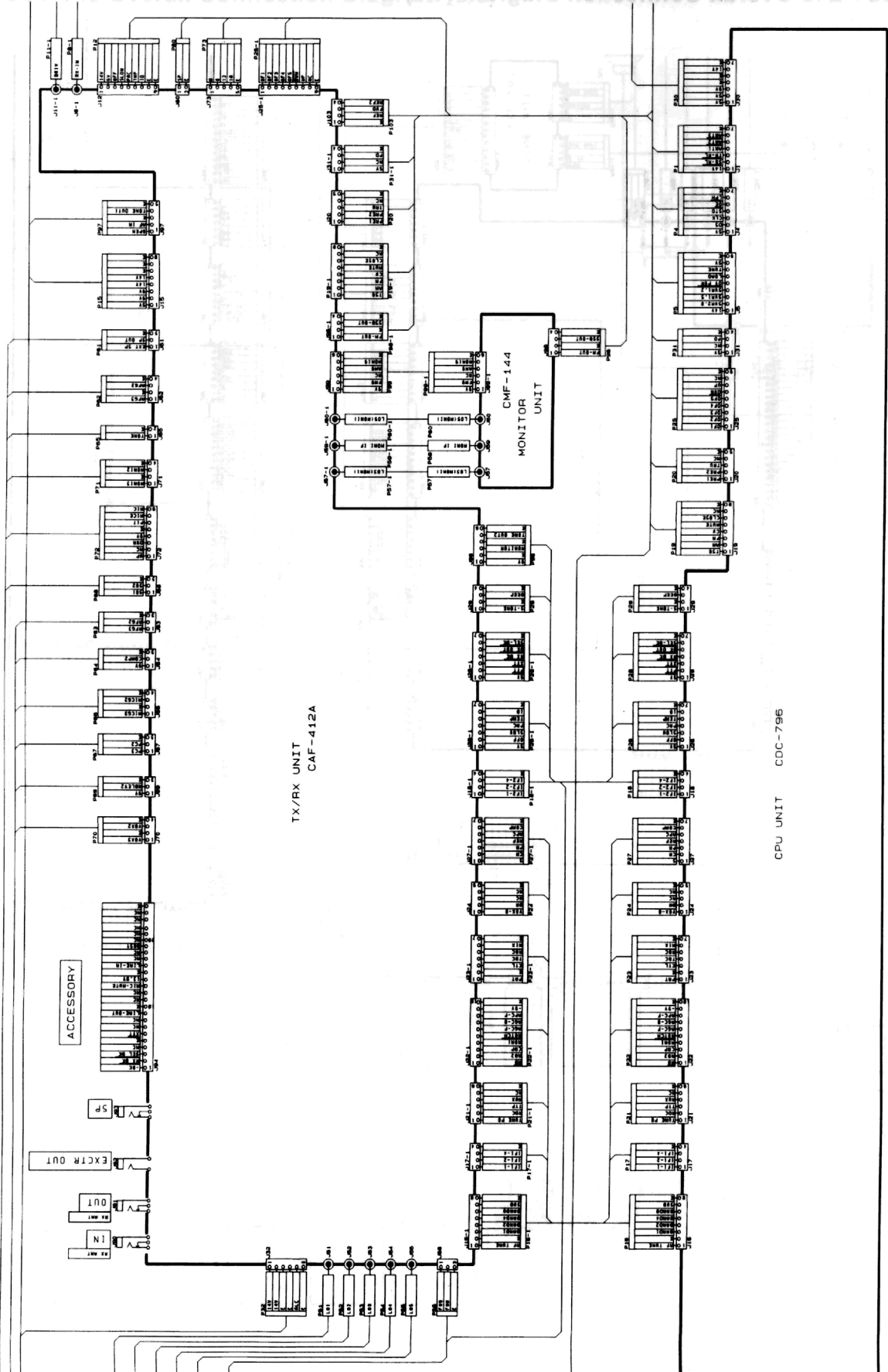

12.12 JST-245 Overall Connection Diagram (3/3)

